



NTSC U/C

PlayStation®

HARD BALL® 99



SLUS-00651
H99SX



ACCOLADE

WARNING READ BEFORE USING YOUR PlayStation® GAME CONSOLE

A very small percentage of individuals may experience epileptic seizures when exposed to certain light patterns or flashing lights. Exposure to certain patterns or backgrounds on a television screen or while playing video games, including games played on the PlayStation game console, may induce an epileptic seizure in these individuals. Certain conditions may induce previously undetected epileptic symptoms even in persons who have no history of prior seizures or epilepsy. If you, or anyone in your family, has an epileptic condition, consult your physician prior to playing. If you experience any of the following while playing a video game - dizziness, altered vision, eye or muscle twitches, loss of awareness, disorientation, any involuntary movement, or convulsions - IMMEDIATELY discontinue use and consult your physician before resuming play.

WARNING TO OWNERS OF PROJECTION TELEVISIONS

Still pictures of images may cause permanent picture-tube damage or mark the phosphor of the CRT. Avoid repeated or extended use of video games on large screen projections televisions. Refer to your projection TV instruction manual for more details.

HANDLING YOUR PlayStation® DISC

- This compact disc is intended for use only with the PlayStation game console.
- Do not bend it crush it, or submerge it in liquids.
- Do not leave it in direct sunlight or near a radiator or other heat source.
- Be sure to take a break during extended play.
- Keep this compact disc clean. Always hold the disc by the edges and keep it in its protective case when not in use. Clean the disc with a lint-free, soft, dry cloth, wiping it in straight lines from the outer edge. Never use solvents or abrasives.

TABLE OF CONTENTS

Getting Ready To Play	3
Pitching	3
Batting	4
Base Running	5
Fielding	6
On-The-Field Controls	7
Menu Controls	7
Setting Up The Game	7
Playing An Exhibition Game	8
Starting A League	14
Draft	16
Playing The Season	19
Training Camp	20
Editing Players	23
Credits	24
Customer & Technical Support	24

Console

Top View

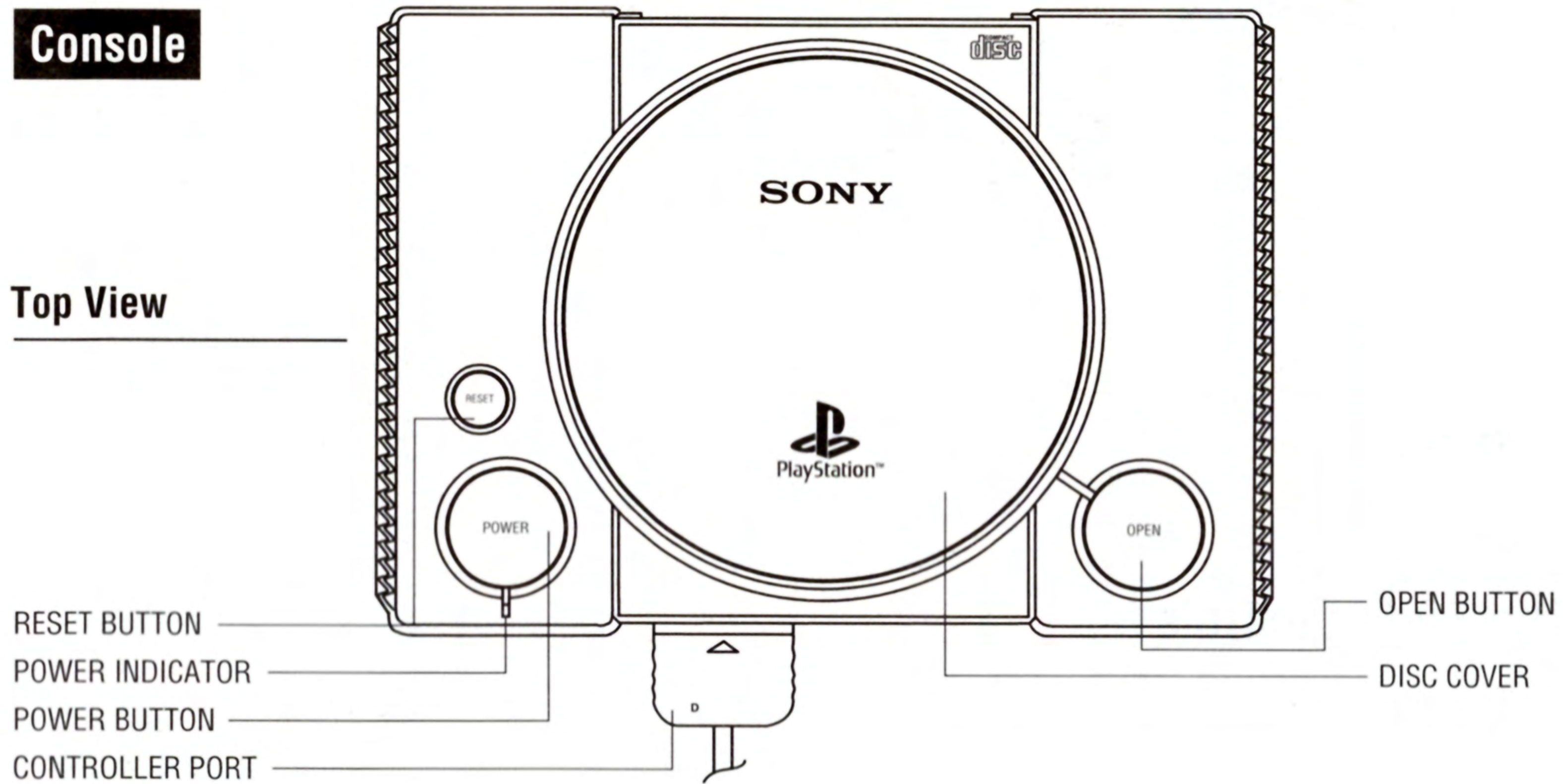

Front View

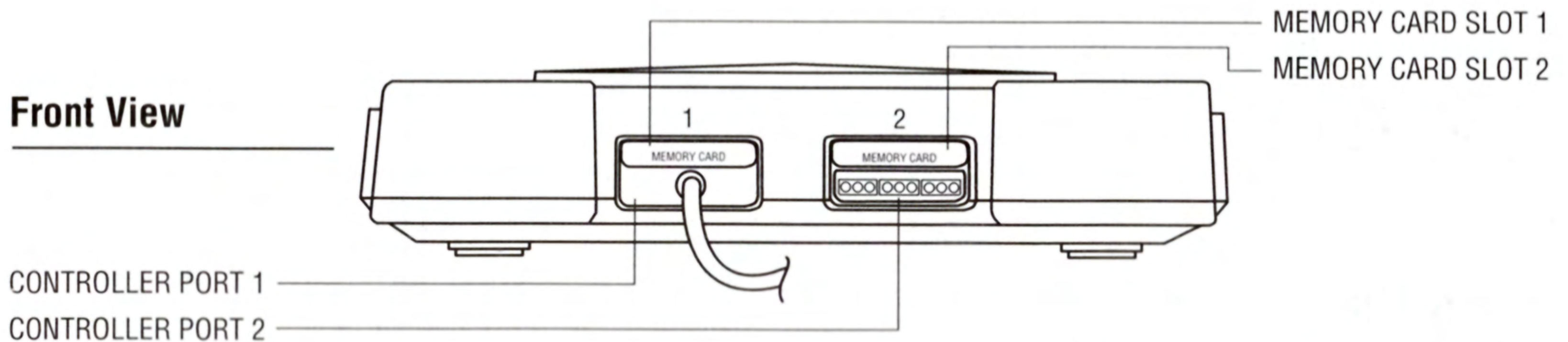

Set up your PlayStation® game console according to the instructions in its Instruction Manual. Make sure the power is off before inserting or removing a compact disc. Insert the game disc and close the disc cover. Insert game controllers and turn on the your PlayStation® game console. Follow the on-screen instructions to start the game.

Front View

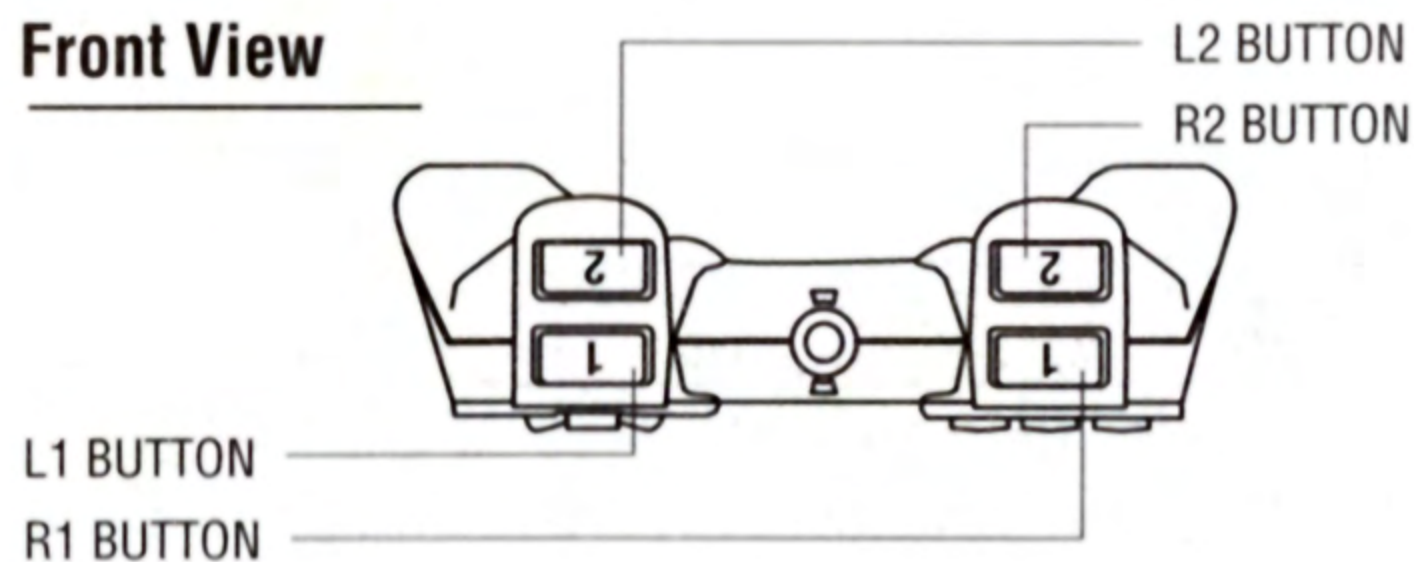

Top View

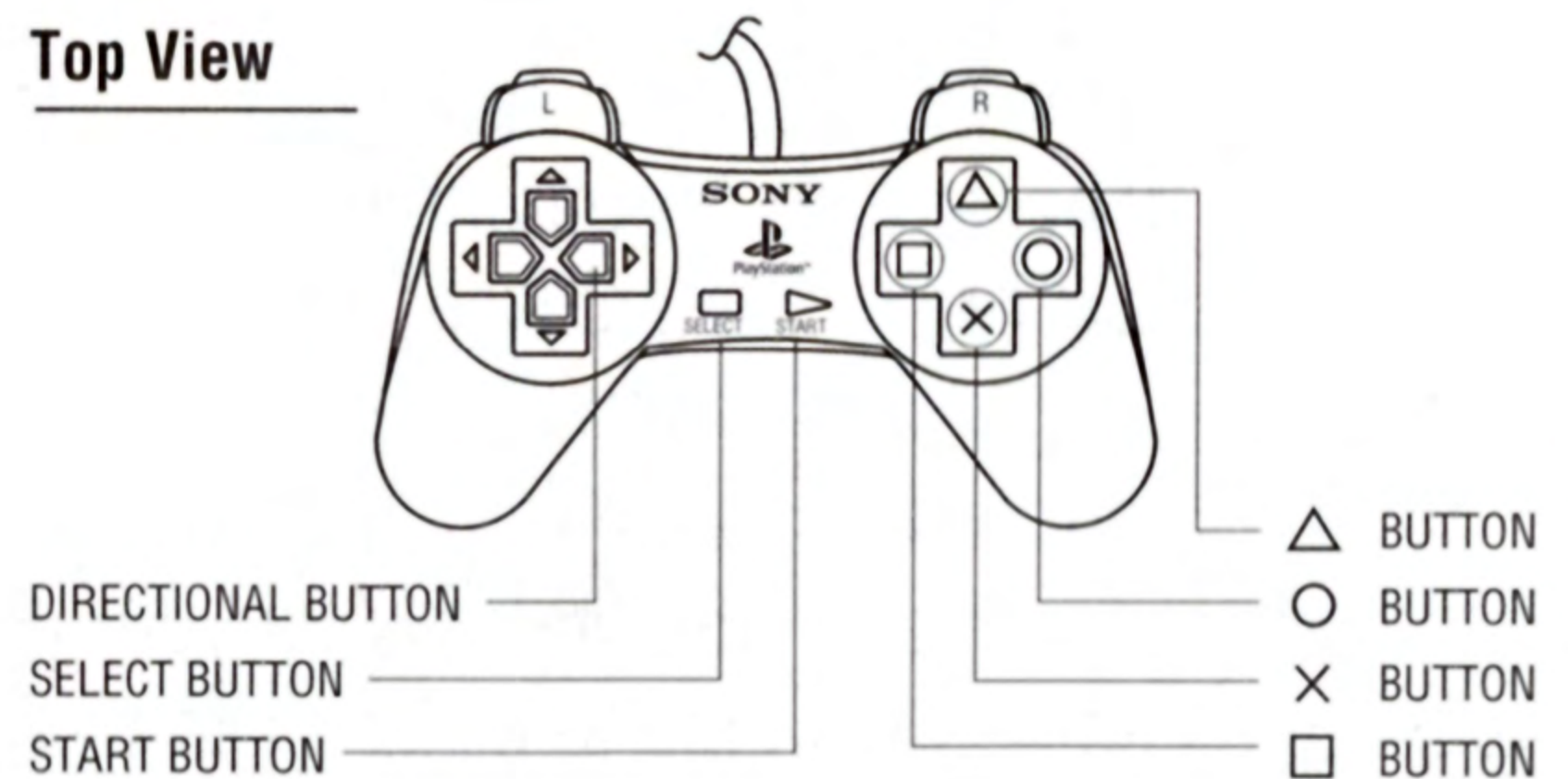

GETTING READY TO PLAY

HardBall 99 brings all of the action of Major League Baseball® to your PlayStation. But before you can move up to the Show, you'll need to master some basic playing techniques. This section will tell you how to bat, pitch, field the ball, and run the bases.

PITCHING

When you are pitching, you'll see a box with your pitcher's name, a status bar measuring his level of fatigue, and your pitcher's selection of pitches. There is also an option for **Strategy**.

To Pitch:

1. Each pitch is assigned a different button on the command button pad. To select a pitch, press the appropriate button.
2. Once your opponent chooses a swing, the batter steps into the batter's box.
3. Press the X to start your windup.
4. Use the **Directional Buttons** to move the crosshair and aim the pitch before the pitcher releases the ball. Tap the **Directional Buttons** lightly to aim.

Note: The top pitch in the list is the pitcher's best pitch.

Note: In a 2 player game when the crosshair option is on, the crosshair disappears just before you finish aiming so your opponent will not see where you're throwing the pitch.

Pitching Strategy:

Choose Strategy to select from the following pitching options. Choose the one you want by pressing the appropriate command button. To return to Select Pitch, press X.

Select Pitch: Returns to the pitching option screen.

Walk Batter: An intentional walk.

IF: Positions your infielders for special plays. Hit ▲ to toggle between the options.

OF: Positions your outfielders for special plays. Hit ● to toggle between the options.

Pitching Advice: Make sure you mix up your pitches. If you use the same pitch over and over again, the batters are going to hit you like there is no tomorrow. Pitch to different locations. You want to keep the batter confused and off-balance. Establish a pattern and then break it to catch him swinging for that third strike.

BATTING

Choosing Batting Options

The **Batting Options** box shows the batter's name, batting average, and speed rating (running speed). Choose from the following options:

Contact: A normal swing. Use this when you want to get on base.

Power: Swing for the fences. You have a greater chance of hitting one out but you also have a more of a chance of making an out.

Opposite: Aim for the opposite field.

Bunt: Lay one down. A skilled bunter can move runners over and get infield hits.

Strategy: Options with runners on base.

To Bat:

1. Choose a swing by pressing the appropriate Command button:

X: Contact Swing

■: Power Swing

▲: Opposite Field









●: Bunt

R1: Strategy

2. The batter steps into the batter's box and the pitcher throws. Watch the crosshair to get an idea of where the pitch is going. You'll need to train your eye to tell the difference between strikes and balls.

3. Press the **Directional Buttons** to target your swing location in the strike zone. The strike zone is a 3x3 grid. Use the table below to help target your swing. Left and right are inside and outside, depending on whether the batter is right- or left-handed.

4. Press **X** to take a normal swing, **■** for a better chance for a ground ball, **▲** for a better chance for a fly ball. Time it well!

SWING AREA		
 High & Left	 High	 High & Right
 Left	No Press Middle	 Right
 Low & Left	 Low	 Low & Right

Batting Strategy:

When you have runners on base, you can choose Strategy by pressing **R1**. This brings up your strategy box, which allows you to select from a variety of options. To choose a strategy, press the appropriate Command button. To return to the Select Swing menu, press **X**. Your strategy options are:

Hit and Run: You must have at least one base runner to select this option.

Steal: You must have at least one base runner to steal a base.

Squeeze: You need a runner on third and less than two outs.

Double Steal: You must have runners on first and second or second and third.

BASE RUNNING:

Once you've gotten a man on base, you need to pay attention, so you can capitalize on your following successes at the plate, and on your opponent's mistakes. You can have your base runners move before the pitch and after the pitch.

Base Running Before the Pitch:

Move your runners with the following controls:

X + Directional Buttons:	Retreat to base.
Directional Buttons:	Lead-Off; Steal
■:	Have every base runner Steal a base.
▲:	Have all base runners take a Lead.
●:	Have all your base runners retreat to their bases.

Base Running After the Pitch:

Directional Buttons:	Advance Runner
X + Directional Buttons:	Retreat to Base
■:	Advance All
●:	Retreat All

FIELDING

Once the ball is in play, you need to be able to direct your fielders to run after the ball, catch it, and throw it back into the infield. To control your fielders, use the following commands:

Fielding (without the ball):

X:	Selects the fielder closest to the ball
■:	Jump or dive
▲:	Gives the fielder a burst of speed.
Directional Buttons:	Moves the fielder.

Fielding (with the ball):

X:	Throw to cut-off man
■:	Bypass cut-off man to throw through to the base.
▲ + Directional Buttons	Run to the appropriate base
Directional Buttons:	Moves the fielder.

When you are fielding the ball, look for the big blue circle on the field. That's the marker that shows where the ball is going to land. Use **X** to select the closest fielder, and move him into that circle. If you can get your fielder there before the ball lands, you'll catch the ball and get an out. If the ball is hit on the ground, you need to move the closest fielder to the ball to scoop it up. Then use the **Directional Buttons** and **X** or **■** to throw to the appropriate base.

ON-THE-FIELD CONTROLS:

During HardBall 99 games, the following controls are always active:

- | | |
|--|---|
| Start: | Pauses the game. |
| Select: | Changes the camera angle. |
| Select (when the game is paused): | Calls a time out and gives you access to the Time Out menu, where you can access a variety of game functions. |
| L1: | Brings up player cards for the pitcher and batter. press once for pic, press quickly twice for stats |

MENU CONTROLS:

You can move between the various windows by pressing the **Select** button. This works on all of the screens.

SETTING UP THE GAME

SELECT GAME

HardBall 99's **Main Menu** offers you five choices for your game play. Use the **Directional Buttons** to choose your option, and press **X** to select it. If you need help with the controls press **■**. Your choices on the **Main Menu** are:

Exhibition Game:

Select this option to play a single game. You'll have a chance to pick which teams, what stadium, and all of the other choices you'd normally make. It's great for getting the feel of HardBall 99, and for specific team match-ups.

League Play:

This option starts a baseball season. You'll find all sorts of options, from the length of the season to drafting players. See the section on **League Play** later on in this manual for more details.

All-Time™ Team:

Here you can play a team made up of the all-time greats, such as Babe Ruth and Lou Gehrig, against any team in the league, against an All-Star team, or against themselves.

Training Camp:

Use this selection to sharpen your playing skills. You can choose between batting practice, fielding practice, and a Home Run Derby™.

Memory Card:

This option gives you access to a variety of memory card functions. You can do the following:

Return to the Main Menu

Load File: You can load a previously saved game.

Save File: Use this option to save the current configuration.

Switch Cards: This allows you to switch between memory cards 1 and 2.

Delete File: Clean out your old games with this option.

Format Card: This option formats a new memory card, erasing all of the existing data. Don't do this to anything important! This choice is not available for formatted cards.

Of course, you should never remove a memory card from your PlayStation while it is loading or saving data.

PLAYING AN EXHIBITION GAME:

When you start an **Exhibition Game**, you'll be asked to make a number of choices. These options determine which teams you'll be playing, which stadium you'll be playing at and so forth. Below is a step-by-step description of the various menu items.

If you have a game saved, you'll be given the chance to resume it, or to start a new game.

Select the Teams to Play:

1. **Select Home Team:** Use the Directional Buttons to choose the home team, and press X to select it.
2. **Select Visiting Team:** Use the same process as above.

Once you've picked your teams, you can move on to the stadium selection process.

Choosing a Stadium:

After you've selected the team, you get a chance to choose the playing field. The default is the home stadium of the home team, of course. However, you can pick any baseball stadium you'd like by using the up and down **Directional Buttons**. You'll find information about the various stadiums in the **Stadium Data** window in the upper right of your screen. Once you've selected the proper stadium, press X.

On the lower left side of your screen, you'll see a listing of the stadium's **Weather Conditions**.

You can use the **Direction Buttons** and X to change these parameters. They are:

Wind: Use X to toggle between **None**, **Light**, and **Heavy**. The wind can affect the flight of fly balls, making them harder to field (and making it harder to hit them over the fences.)

Surface: You can pick between **Dry**, **Damp**, and **Wet** with X. A wet infield is a slow infield, giving the players a greater chance to field the ball. However, damp and wet infields also contribute to player injuries.

Humidity: This can affect the flight of the ball. If the humidity is very low or very high the pitcher will tire out much more quickly.

Temp: This option changes the temperature of the stadium to the displayed value. Use the **Direction Buttons** and X to put in a new number. If it is very hot, pitchers will get tire more quickly.

NOTE: In order to abort an Exhibition game or Home Run Derby™, call a time-out, select **Lineups** and then **Main Menu**. In order to abort a League game, call a time-out, select **Lineups** and then **League Standings**.

Pre-Game:

There are a lot of options here, and they can all affect your game. Use the **Direction Buttons** to move around and \times to make your choices. The various selections are:

Play Ball!: This starts the game.

Visiting Team & Home Team: These options show up as the two teams' logos, and choosing either one will take you to a sub-menu with the following choices:

Sub Plrs: You can change your line up with this option. Put in players to face that day's pitcher, change your pitcher, and juggle things around. Use the **Directional Buttons** to select the player you'd like to remove from the line-up and press \times . Then select the player from your bench (or bullpen) you'd like to substitute, and press \times to complete the process. This is the same method you'll use to make changes to your roster during a game.

While you have a player highlighted, you can use \bullet to switch between four sets of statistics for the players.

Note: You can tell which screen you are looking at by the number tab in the upper right of each window. If you would like to customize your statistical sets on any screen with numbered tabs, highlight a player, and press and hold \bullet .

Bat Order: Create a custom batting order with this selection. Select a player in your batting order with the Directional Buttons, and press \times . Move to the position you want that player bat in, and press \times to swap the two players. This is available pre-game only.

vs. LHP: Use \times to toggle between lines up designed to face left-handed pitchers and right-handed pitchers. Your current line-up is listed at the top of your Roster screen in the upper left.

Fielder Positions: Use this option to change your infielders' and outfielders' position. You will use this during games, to put on defensive shifts for specific batters. You can also set up custom infield/outfield positions by selecting Custom.

Bullpen: This option lets you tell pitchers to warm-up, and allows you to make a pitching change. Remember, you want to give your relievers time to warm-up before you bring them into a game, or they'll be throwing all over the place. However, don't let them stay throwing in the bullpen for too long, or they'll get tired out.

Return: Brings you back to the **Pre-Game** menu.

Options: This menu choice gives you access to a wide variety of playing options. Use the Directional Buttons to move up and down the list, and X to pick among the following options:

Controls: This choice allows you to determine which teams are controlled by players and which are controlled by the computer, and also allows you access to some Managers Options.

Controls: Use the **Directional Buttons** to switch between the two teams, and X to pick from Controller 1, Controller 2, or PlayStation Controlled. You can also select an alternate controller configuration here, using the Configure option.

Manager Options: For human-controlled teams, you can set various options to on or off. By letting the PlayStation handle some of the work for you, such as Throwing or Fielding, you can concentrate on the other aspects of the game. Add more and more player control as you get more comfortable with HardBall 99.

Pitching: If you'd like the PlayStation to pitch for you, turn this option off.

Batting: Turning this option off lets the PlayStation handle the batting chores, You just have to decide to hit, to take a pitch, or to bunt.

Fielding: If this option is active, you have to move your fielders to get the ball. If it is inactive, the PlayStation will handle it for you.

Throwing: When deactivated, the PlayStation will automatically throw the ball in fielding situations. Otherwise, you have to do that yourself.

Base Running: If you have this option deselected, the PlayStation will do your base running for you.

Substitutions: When this is active, you have complete control over your roster, and have to make all changes. If it is deselected, the PlayStation will make changes as needed.

Fielder Positions: When this is deselected, the PlayStation will shift your fielders positions to cover special play situations.

Level of Play: You can change a variety of playing options from this menu. Once again, use the **Directional Buttons** to navigate the menu, and **X** to make your choices. Your options are:

Difficulty Level: From this window, you can control how hard the game is to play.

Home Team & Visiting Team: Use the **Directional Buttons** to highlight the appropriate slider, and then hold down **X** and use the Right or Left **Directional Button** to adjust the level of play between Easy and Hard. Choose an easier setting to allow a greater margin of error for fielding, throwing and hitting. At the harder setting, a player (or your opponent) must execute the same plays with greater precision.

Game Speed: You can adjust the speed of the game between Slow and Fast using the method detailed above.

One Pitch Mode: When activated, this option causes all of the batting results to be decided by a single pitch. You'll live and die by a single swing. Perfect for speeding up games.

Level of Play: This window lets you control a number of game options. All of these options can be toggled on or off by using the **Directional Buttons** to select the option and then pressing **X** to change it.

Fielding Errors: If you want the players to have a chance to make mistakes, turn this on. If you want flawless performances, turn off this option.

Injuries: When this option is active, players have a chance of getting hurt and being forced to leave the game.

Pitch to Center: This option disables the pitching crosshair, forcing the pitcher to throw consistently down the center.

Pitching Crosshair: When this option is active, you can see the pitching crosshair. When it is turned off, you won't see the crosshair, although you'll still be able to aim your pitches.

Pitcher Fatigue: The pitchers will tire out when this option is in use, and their pitch quality will start to suffer when they do.

Pitcher Warmups: Pitchers will need some time to get ready to play when you are using this option. When it is deactivated, you can put replacement pitchers in the game with no preparation.

Fielding Marker: When this option is active, you'll see a big blue circle where the ball is going to land. When it is off, you'll have to use your own judgement.

Base Stealing: If you want to be able to steal bases, turn this option on. Otherwise, you won't be able to.

Player Ratings: This options uses the player's statistics for helping to determine whether they hit the ball, baserunning, etc. If you want to depend on your own talent, turn it off.

Designated Hitter Rule: When selected, the game uses the Designated Hitter Rule. Note that this is turned off as a default for games played in a National League park, and turned on for games played in an American League stadium.

Innings: You can determine the number of innings the game will last with this menu item.

Graphics: HardBall 99 gives you a number of different cameras from which you can view the game. This menu gives you control over those angles, allowing you to set the Fielding Camera and the Batting Camera. You can also change the stadium from this menu.

Sound: You control your sounds options here. Your choices are:

SFX Volume: Hold down X and use the Directional Buttons to change the volume of the special effects from between Max and off.

Music Volume: You can control the music in the same manner as you do the SFX.

Sound Effects: Use X to toggle these on and off.

Crowd Noise: You can turn the crowd noise on and off by pressing X.

Announcer: If you don't want to hear the announcer, turn this option off.

PA Echo: For real ballpark sound, turn this option on.

Save Game: You can save your game by using this option.

Box Scores: You can look at the various players' performances in the current game with this menu item.

Highlights: Review the exciting events of the game you've just played, and even edit and save your own highlight reel of the game!

Playing the Game:

Once you've made all of your choices, you're ready to play the game.

STARTING A LEAGUE:

League play is more complicated than Exhibition play. You'll be following the successes (and failures) of all of the teams in both leagues, leading up to the Championship series. But before you can play, you'll have to do some set-up.

Pre-Game:

When you set up a league, you'll find yourself on the **Pre-Season** screen. To get started, you and your friend should select the teams you want to play. Only two teams can be user-owned at any time.

Team Summary: Highlight and select a team from the Pre-Season Standings screen. From this screen, you can do all sorts of team management tasks. Let's start with the most important one:

Buy Team: If you have selected the team you'd like to play in the league, highlight this option and press X. The team becomes yours to control, and you'll get the chance to name the manager. (To customize the manager, see the section on the Manager Profile later on in this chapter.)

Calendar: A monthly schedule of the team's League games.

Roster: Selecting the Roster option moves you into the standard Team information window, much like the one you've used in Exhibition games. However, there are some differences. You'll use the **Sub Plrs** and **Batting Order** to make lasting changes in your line-up. The

Bullpen option is used to make changes in your starting rotation, and to move pitchers to and from the Bullpen. There are also a couple of new choices:

Trade & Sign: When you select the Trade & Sign option, you are presented with a screen full of various windows. You can use these windows to manage your players:

Active: This window shows the current players on your Major League roster.

Minors: Your Minor League players are listed here.

Disabled: If you have moved any injured players to the Disabled List, they'll be shown here.

Released: This window shows the players that you have released from your ball club.

Signed: If you have signed any Free Agents, they'll be listed here. You'll need to move them to your Major League roster, or to the Minors.

Trades (Sent & Received): When you are making trades, the Sent window shows the players are you sending to another team, and the Received window shows the players that are being sent to you.

Move Players: This button allows you to move players from one roster to another.

Press **X** to select this option, and then use the **Directional Buttons** to select the player you want to move.

Trade Players: If you select this option, you're getting ready to offer a trade to another team. Select the player you would like to trade, select the team you'd like to trade with, and select the player you want from that team. When you have all of that done, press the **Offer Trade** button. The computer will consider the merits of your offer and then accept or decline. You may leave a player or players up for trade during the season, and the computer may choose to trade for those players as the season progresses.

Free Agents: Once again, this option brings you to a sub-menu, where you'll see all of the currently available free agents. You have a couple of options here:

Move Players: This will allow you to move players among your rosters, opening space for free agents.

Sign: To sign a Free Agent, click on the Sign option, highlight the free agent's name using the **Directional Buttons**, and press **X**. The free agent will be moved over to your Signed roster. You'll need to assign him to one of your active rosters.

News: This option shows you the current news headlines.

Lineup: This returns you to the Lineup screen.

Manager Profile: You can adjust the behavior of your manager in this window. Your manager is a complex man, and you have a number of behaviors you can modify:

Slow Hook - Quick Hook: This adjusts how likely the manager is to pull a struggling pitcher from the game.

Don't Steal - Steal Lots

Hold Runners - Push Runners: This is a measure of aggressiveness on the part of your base runners.

Sacrifice - Hit Away: Do you want your manager to play the game one base at a time, or do you want to go for the big hits? If your manager leans towards sacrifice, he'll have the players try to move the base runners along into scoring positions with bunts, sacrifice flies, hit and runs, and other tactics. If your manager wants your players to hit away, he'll be more inclined to let them swing, and see what develops.

Defense - Offense: Is your manager going to gear your line-up towards big bats or solid defensive players?

Favor Speed - Favor Power: Do you favor quick players, or players with lots of power?

Rookies - Veterans: This is your last choice for the line-up. Do you want your manager to give your hot young talent a chance? Or would you like him to favor experienced, proven players?

Team Profile: You can change the team name, your manager's name, the stadium you play in, and even your team's logo from this window.

Draft:

Draft Pool: This is a listing of all of the players available for the draft. You can inspect them, and then choose to proceed with the draft or skip it altogether.

Teams: This shows the order in which the teams will draft new players. This order can be altered via the Draft Order window.

Draft Order: You can adjust the order in which teams get to draft players.

Cycle: The draft order goes down the list of teams, and when it hits the last team, it starts over from the top.

Zig Zag: The draft order starts at the top of the list, and reverses the order when it hits the bottom.

Random: The draft order is completely random.

Display Computer Picks: The computer will pause after every draft pick so you can review who each team is drafting. You can toggle this option on and off by using X.

Start Draft: The computer will begin the drafting process. Computer-controlled teams will make their picks, and the game will bring up the Draft window, where you have several options:

Draft Player: Use the Directional Button to highlight the player you'd like to draft, press Select to get down to the Draft Player option, and press X to add the player to your roster.

Manager Advice: If you aren't certain who you'd like to draft, ask your manager.

Skip Round: There are times where you're happy with your roster, and don't want to make any additions or changes. If that's the case, choose this option to pass on your turn to draft a player. The draft continues, and you'll still get a chance in the next round (assuming there are any players left for you to take.)

Skip Remaining: This option skips all of the remaining draft rounds for your team. You must think you're pretty good as you stand!

Release Player: If you want to make room on your rosters, or just think you're carrying some deadweight, this is the option to use.

Abort Draft: This cancels the drafting process and returns you to the Standings menu. You can start the draft up again, and correct any mistakes you might have made.

Skip Draft: If you don't want anyone to draft any new players, select this option and press X. You'll return to the Standings Screen.

Abort Draft: This cancels the drafting process and returns you to the Standings menu. You can start the draft up again, and correct any mistakes you might have made.

Start Season: This selection begins the current season. Your choices are:

Full Season: Play a full 162-game season, and then move on to the play-offs and the World Series.

Half Season: Play 81 games before post-season play starts.

Short Season: Play a 20-game season, and then move on to the post-season.

Custom: You can set the length of the season here, and the length of the play-off series, the League Championship series, and the World Series. You can also activate or deactivate inter-league play and the All-Star Game. When you are satisfied, highlight the Build option and press X.

Options: This selection brings you to the League Options window, where you can decide some very important things.

League Options: You can rename the leagues, change their logo, and decide if they are going to use the Designated Hitter rule.

Options: You have the ability to change some of the way the computer acts:

Injuries Can Occur: Toggle this on and off to allow or prevent player injuries.

Computer Makes Trades: When this is on, the computer will make trades with you and other players. When it is off, the computer won't initiate any trades.

Computer Declines Trades: The computer has the ability of saying "no" to a trade if this option is active.

Include All-Time Team: Substitute in the All-Time team for any other team in the league.

Create New League: If you highlight this option and press X, you'll erase all of the work you've done and create a brand-new league.

Reset to Pre-Season: This option resets the standings to the pre-season point, allowing you to play the season over again. If you've just finished a season, this option will move the league on to the next year. Once the season is completed, this option button becomes **Start Next Season**.

League Leaders: This option isn't active before the season starts.

News: During a season, you can read all the teams' news on injuries, trades and retirements.

Playing The Season:

Once you have finished with all of the pre-season set-up, it is time to play some baseball! When you start a season, you're shown the **Standings** screen, and presented with six options:

Schedule: This moves you to the **Schedule** screen, where you can choose which games you'd like to play. Use the **Directional Buttons** to move to the match-up that you want to play out, and press X. You'll be offered a screen with the choices to **Simulate the game**, or **Play Out In Full**.

Prev Week: Moves the Schedule screen back to the previous week, so you can review the scores of the various games.

Next Week: Moves the schedule to the next week, so you can see which match-ups are coming. This is useful for altering pitching rotation and planning other strategies.

Simulate Week: This option plays out the week's worth of games and displays the results.

Simulate Season: Like Simulate Week, but for the entire season. If you wish to halt the simulation, press ▲ and you will have access to all of the in-season options.

Tourn Tree: When you are in post-season play, this option will show the tournament tree.

Return: Takes you back to the **Standings** screen.

Options: This gives you access to the League Options, as described above.

League Leaders: You can display the leading players in a variety of categories, including batting, pitching, position players, infielders, outfielders, and designated hitters. You can filter this information by league or by a specific team.

MVP Awards: This displays end of regular season pitching and batting MVPs.

News: This option will display a window full of news items. These items report on player injuries, trades, and other breaking news.

Return: Returns you to the **Main Menu**, where you can save your season. To return to the season in play, just select the **League Play** option.

ALL-TIME™ TEAM

This selection gives you a chance to play, or play against, the all-time greats. The All-Time Team is composed of such great players as Babe Ruth, Jimmy Foxx, Shoeless Joe Jackson, and others. When you select this option, you set up a game as you would for an Exhibition game. However, in the team selection screen, you have a chance to pick the All-Time Team. You can play the All-Time Team against any of the regular league teams, against one of the All-Star Teams, or even against itself!

TRAINING CAMP

The Training Camp option lets you practice some of your basic playing skills and participate in the Home Run Derby. When you select this menu item, you are given three choices:

Batting Practice:

When you start batting practice, you'll move to the team selection screen. Pick your team, and then move on to pick and adjust the conditions at the stadium of your choice. Highlight the player in the roster you want to practice with. Once you've made those decisions, you'll have some more options:

Roster: If the player you want to practice with is not in the lineup, use the Batting Order option to substitute him in.

Options: This brings you to a familiar sub-menu. However, some of the items control different things now:

Controls: You can choose and configure your batting controller.

Settings: Your options are limited here:

Game Speed: Choose between Slow and Fast. The faster the game, the harder it is to get the bat on the ball.

Pitch Types: You can toggle the various types of pitches (Changeup, Curveball, Fastball, Screwball, Sinker, Fastball!, Slider, and Knuckleball) on and off. If you want to practice against a single type of pitch, select just that one pitch type. If you want the pitcher to mix them up, choose a variety of pitches. You can also choose where you want the pitcher to throw the pitches:

Center of the Zone: The pitcher will throw you sweet, hittable pitches down the center of the strike zone.

High/Low: The pitches will vary between high and low, to give you some practice at judging them.

Inside/Outside: The pitches will wander from side to side, once again helping you learn how to swing at the various pitches.

Random: Just like in a ball game. The pitcher is going to throw you anything he feels like, and it's up to you to hit them.

Graphics: As per the standard menu item.

Sound: As per the standard menu item.

Once you've made all of your choices, you'll get to play your chosen hitter swinging at as many pitches as you want him to. When you are done, call a time-out by pressing **Start** and then **Select**, go to the Lineup option, and select **Main Menu**.

Fielding Practice:

You'll need to select a Home and Visiting team this time. The Home team is the one you'll be practicing fielding with; the Visiting team will be hitting. After that, choose your stadium. Then proceed on to the standard menu items:

Roster: Set your defensive line-up with this option. You can ignore all of the other choices.

Options: This brings you to a familiar sub-menu. However, some of the items control different things now:

Controls: You can choose and configure your fielding controller.

Settings: Your options are limited here:

Game Speed: Choose between Slow and Fast. The faster the game, the harder it is to get the bat on the ball.

Hit Types: You can pick the types of hits you'd like to field. Your choices are Flies, Grounders, and Bunts. You can pick one, two, or all three of those types of hits to practice against.

Fielding Marker: You can turn the Fielding Marker on and off with this option.

Base Runners: You can choose to start with runners on first, second, and/or third base, to practice specific fielding situations.

Outs: Select whether there are none, one, or two outs when you start. Once again, you can use this to set up specific fielding situations.

Graphics: As per the standard menu item.

Sound: As per the standard menu item.

When you have everything set up just as you like it, select **Play Ball!** to start your practice. You'll see your pitcher facing a batter. Press **X** to get your pitcher started, and go from there.

Home Run Derby™ :

This game lets you compete for hitting the most home runs. To begin, pick a team and a stadium, and then move on to the choices below.

Roster: Use this option to pick the player to want to participate with. Make sure you move that player to the number one slot in your batting order.

Options: This brings up the options menu:

Controls: You can choose and configure the batting and pitching controllers. You can swing against the computer, or compete against a friend's pitching.

Settings: Your options are limited here:

Game Speed: Choose between Slow and Fast. The faster the game, the harder it is to get the bat on the ball.

Pitch Count: How many pitches does your batter get? Pick from 3, 5, 10 or 20 pitches.

Graphics: As per the standard menu item.

Sound: As per the standard menu item.

When you are ready, select **Play Ball!** to start the Home Run Derby™. Your batter will step in the batter's box. Press **X** to get started. You'll score 1000 points for each ball you hit out of the park, and fewer points for any ball you hit into play.

EDITING PLAYERS

HardBall 99 lets you edit the players, to adjust their characteristics to bring them in line with what you feel they should be, or just to make super players. You can change almost everything about a player. Highlight a player or pitcher on the Roster screen and press X. Most of the characteristics are defined by a number from 1 to 99.

Position Players:

F.A.: Fielding accuracy

GND%: The Percentage of balls hit on the ground.

Pull%: How often does the batter pull the ball?

CL/LATE: Close/late in game rating

SC.POS: Runner in scoring position rating

Pitchers:

Stam: What is the pitcher's stamina? How fast does he get tired?

Acc: How accurate is the pitcher with his pitches?

FS: Fastball

CV: Curveball

CU: Changeup

SL: Slider

SI: Sinker

Kn: Knuckleball

SC: Sliding Curve

Remember, the higher the number, the better!

CREDITS

Design: Mike Benna, Jeff Sember, John Boechler
Programming: Mike Benna, Jeff Sember, Joel Dinolt
Art and 3D Miracles: John Boechler
Sound Effects: Tommy Tallarico
Announcer Editing: Brian Shaw
Additional Programming: Starsphere Interactive: Andrew Iverson, Henrik Markarian

Game Music

Composer/Producer: Brian Shaw
Guitarist: Andrew Duncan
Synthesizer Solos: Joe Bashorun
Bass Guitar: Gary Janzen
Studio Provided by: Henri Brown
Recorded and Mixed at Meshra Studios, Surrey, B.C.

Executive Producer: Pam Levins
Associate Producer: Michael Person
Lead Artists: Bill Spence, Molly Windsor
Illustrators: Tracey Madden, Juan Ortiz

QA Manager: Brian Gilmer
QA Lead Analysts: Arnold Galano, Alex Jones
QA Analysts: Donny Clay, Jason Cordero, Jacob Martin, Shawn Shinn, Josh Simpson, Ted Tomasko

Senior Brand Marketing Manager: Steve Allison
Licensing Manager: Gabrielle Benham
Documentation: Bruce Harlick, W.D. Robinson
Marketing Services: Mark Glover, Matt Abrams
Online Marketing: Ray Massa, Daniel Grove
Voice Over: Greg Papa

Special Thanks: Matt Abrams, Jim Barnett, Ken Caminiti, Roy Cooler, David Costello, Mark Daag, Jill Dos Santos, Pete Enfield, David Foster, Mark Glover, Daniel Grove, Cecelia Hernandez, Neil Johnston, Evan Kaplan, John Koronaios, Rachel Kram, Erica Krishnamurthy, Wayne Leonard, Rusty Levins, Christine Lugton, Michael Luscher, Ray Massa, Laurie Mendez, Roger Nelson, Sandi Ricci, Stan Roach, Rick Sabaag, Brad Schlachter, Melanie Sherk, Jack Symon, Kathie Tompkins, Rhoda Wawrzynski, Brent Wilkinson, Emily Williams, ST Labs

ACCOLADE CUSTOMER & TECHNICAL SUPPORT

Accolade provides customer service, news, demos, technical support on these on-line services:

PHONE: Accolade can help you by phone between the following hours:

Monday - Thursday 8:00am - 5:00pm PST and Friday
9:00am - 5:00pm PST at (408) 296-8400

FAX: Faxes may be sent anytime to: (408) 246-0231

INTERNET: website – <http://www.accolade.com>
email – techhelp@accolade.com

POSTAL: Accolade Tech Support
5300 Stevens Creek Blvd., Suite 500
San Jose, CA 95129

SOFTWARE WARRANTY

Accolade, Inc. warrants for a period of 90 days from the date of purchase by the original purchaser of this software that the medium on which it is recorded will be free from defects in materials and workmanship. Defective media which has not been subjected to misuse, excessive wear or damage due to carelessness may be returned during the 90 day period without charge. To receive warranty service:

1. DO NOT return your defective compact disc to the retailer.
2. Notify Accolade Customer Service of the problem by calling (408)296-8400 between the hours of 8am and 5pm (Pacific Time) Monday through Friday. Please do not send your compact disc to Accolade before calling. Accolade can also be reached 24 hours a day by FAX at (408)246-0231, or by email at techhelp@accolade.com. Check us out on the World Wide Web at <http://www.accolade.com>.
3. If a Customer Service Technician is unable to solve the problem by phone, you will be given a Return Authorization number. Record this number on the outside packaging of your compact disc (be sure your packaging is at least 4"x6", as many shipping companies will not ship anything smaller). Send the compact disc and your sales slip or similar proof-of-purchase within the 90-day warranty period to: Customer Service, Accolade, Inc., 5300 Stevens Creek Blvd., Suite 500, San Jose, CA 95129. After the 90-day period, defective media may be replaced in the United States for \$10 (U.S. dollars; plus 8.25% sales tax if the purchaser resides in California). Make checks payable to Accolade, Inc. and return to the address listed above. (To speed processing, please do not return manuals or game boxes.)

COPYRIGHT NOTICE

HardBall 99 is a registered trademark of Accolade, Inc. The All-Time team is a trademark of Accolade, Inc. ©1998 Accolade, Inc. Created by MindSpan. Officially Licensed by Major League Baseball Players Association ©MLBPA. Major League Baseball trademarks and copyrights are used with the permission of Major League Baseball Properties, Inc. Various players under rights licensed by CMG Worldwide, Inc., Indianapolis, Indiana 46256. All other trademarks and registered trademarks are properties of their respective owners.

LICENSE AGREEMENT

This computer software product (the Software) and user manual is provided to the Customer under license from Accolade, Inc. and are subject to the following terms and conditions, to which the Customer agrees by opening the package of the Software, user manual and/or using the Software. Granting of this license does not transfer any right, title or interest in the Software, or user manual to the Customer except as expressly set forth in this License Agreement. The Software and user manuals may not be copied for any reason. The Customer may not transfer or resell the Software or user manual. The remedies provided above are the Customer's sole and exclusive remedies.

In no event shall Accolade, Inc. be liable for any direct, indirect, special, incidental or consequential damages with respect to the Software or the user manual. Except as provided above, Accolade makes no warranties, either express or implied, with respect to the Software or user manual, and expressly disclaims all implied warranties, including, without limitation, the warranty of merchantability and of fitness for a particular purpose.

Test Drive[®] 5 is Racing to a Store Near You Christmas '98



NTSC U/C

PlayStation[®]



Killer Soundtrack Featuring:
Fear Factory
Gravity Kills
Junkie XL
KMFDM
Pitchshifter

TEST DRIVE[®] 5

EVERYONE
E
CONTENT RATED BY
ESRB
SLUS-00610
T05SX

"...the **MUST HAVE** racing game of 1998"
- PSExtreme

ACCOLADE

Accolade, 5300 Stevens Creek Boulevard, Suite 500 ± San Jose, CA 95129
HardBall[®] is a registered trademark of Accolade, Inc. HardBall 99 ©1998 Accolade, Inc. Created By MindSpan.
Officially licensed by Major League Baseball Players Association ©MLBPA. Major League Baseball trademarks
and copyrights are used with permission of Major League Baseball Properties, Inc. Various players used under
rights by CMG Worldwide, Inc. Indianapolis, Indiana 46256

Licensed by Sony Computer Entertainment America for use with the PlayStation game console. PlayStation and the PlayStation logos are
trademarks of Sony Computer Entertainment Inc. The ratings icon is a trademark of the Interactive Digital Software Association.
Manufactured and printed in the U.S.A. THIS SOFTWARE IS COMPATIBLE WITH PLAYSTATION GAME CONSOLES WITH THE NTSC U/C
DESIGNATION. U.S. AND FOREIGN PATENTS PENDING.

ACCOLADE



®